

MILLIAMP CALIBRATOR MODEL 334A

- **ALL 4 TO 20 MILLIAMP LOOP FUNCTIONS**

Source milliamps
Simulate two-wire transmitters
Read milliamp outputs
Power & Measure two-wire transmitters
Read DC Volts to check loop power supplies

- **COMPACT AND LIGHTWEIGHT**

Easy to carry – Weighs less than a pound
Includes padded nylon carrying case with shoulder strap and belt loop

- **ACCURACY TO $\pm 0.03\%$**

Within ± 0.02 mA from 4 to 20 mA

- **LONG LASTING ALKALINE BATTERIES**

Three “9V” Alkaline batteries last many shifts
Optional AC Adaptor for full-time bench use

- **“QUIK-CHEK” SWITCH**

Instantly output 4.00 and 20.00 milliamps
Adjust the output from any Quik-Chek output

- **MILLIAMP OR PERCENT DISPLAY**

Source or Read from 0.00 to 24.00 mA or from
-25.0 to +125.0% of 4 to 20 mA span

- **OVERLOAD PROTECTED**

Withstands 135 Volts AC/DC without fuses



GENERAL INFORMATION

EASY TO USE

The Altek Model 334A will check, calibrate and measure all your current signal instruments in a 4 to 20 milliamp DC loop. Use at every point in your loop. Source & Read 0.00 to 24.00 mA, Simulate a Two-Wire Transmitter or use the Model 334A to simultaneously Power & Measure your Two-Wire Transmitters. Toggle the display to show milliamps or percent of 4 to 20.

SOURCE MILLIAMPS

Calibrate recorders, digital indicators, stroke valves or any other instruments that get their input from a 4 to 20 mA loop. Easily set any value to within 0.01 mA with the speed sensitive digital potentiometer.

RECALL OUTPUT SETTINGS

The “QUIK-CHEK” switch provides rapid checking of 4.00, 20.00 and a third point between 0.00 to 24.00 mA.

CALIBRATE USING LOOP POWER

Check loop wiring and receivers by using the Model 334A in place of a 2-Wire transmitter. Simulate a

changing process input to check loop response and control settings. The Model 334A uses any loop power from 3 to 45V DC.

READ LOOP CURRENT

Check controller outputs or measure the milliamp signal anywhere in the loop. The Model 334A measures 0.00 to 24.00 mA signals with much greater accuracy than a typical multimeter. Toggle the display to show milliamps or percent of 4 to 20.

POWER & MEASURE 2-WIRE TRANSMITTERS

Simultaneously measure the output of a 2-Wire Transmitter while using the internal batteries to supply up to 27V DC to power the transmitter. Handy for checking transmitters in the field or on the bench.

READ DC VOLTS

Measure from -99.99 to +99.99 VDC with 10mV resolution. Use it to check loop power supplies, I/V converters, 1 to 5 Volt signals and battery voltages.

OPERATING INSTRUCTIONS

GENERAL

TURN-ON



Move the slide switch left to mA to calibrate in mA or right to % 4 TO 20 mA to calibrate in percent. The left hand toggle switch is then used to select SOURCE, READ or 2 WIRE TRANSMITTER SIMULATOR.

To READ DC VOLTS move the slide switch all the way to the left and place the left hand toggle switch to READ.

TURN OFF

Move the slide switch to OFF to turn the 334A off.

mA or %

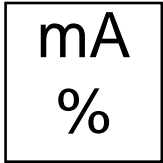

Choose mA to display directly in milliamps. Select % 4 to 20 mA to display in percent of span for 4 to 20 mA loops. Percent is also used with chart recorders, valves or current trips that display in percent.

100.0%	20.00 mA
75.0%	16.00 mA
50.0%	12.00 mA
25.0%	8.00 mA
0.0%	4.00 mA

To convert from Percent to Milliamps
 $\text{Percent} = (\text{mA} - 4) / 0.16$

To convert from Milliamps to Percent
 $\text{mA} = (\text{Percent} / 6.25) + 4$

CHANGING BATTERIES

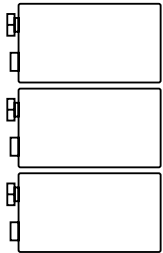

Low battery is indicated by BAT on the display. Approximately four hours of typical operation remain before the 334A cannot supply the full output into a load. When the batteries are too low for the 334A to operate, the LCD blanks and Model 334A shuts itself down. Turn the 334A off, remove the four screws securing the housing and lift the calibrator out of the housing. The three "9V" batteries are easily removed and replaced (alkaline supplied and recommended). Replace the calibrator in the housing and replace the screws.

OUT OF RANGE SIGNALS

Signals below 0 mA or open circuits are indicated by 0.00 mA (-25.0%) on the display. Signals above 52 mA are current limited by protection circuitry to approximately 55.00 mA.

KEEPING THE PROCESS GOING

When an instrument in a critical control loop develops a problem it is important to maintain control of the process. The Model 334A can be temporarily substituted for a faulty controller or transmitter to provide a manual loading station. One technician takes manual control of the process while a second technician retrieves and configures a replacement instrument.

SOURCE MILLIAMPS or 2-WIRE SIMULATOR

Select SOURCE to output from 0.00 to 24.00 milliamps using the internal batteries as the power source. Select 2-WIRE SIMULATOR to control the current in loop that has an operating power supply. To change the output value turn the speed sensitive digital potentiometer (konb). The faster it is turned, the faster the output will change. This function operates in all three output positions (HI, SET & LO).

RECALLING QUIK-CHEK OUTPUTS

QUIK-CHEK® Instantly output 4.00 or 20.00 mA by moving the Quik-Chek switch to the 4.00mA / 0.0% position or 20.00mA / 100.0% position. For fast three point checks select the ADJUST position. The Model 334A automatically remembers the last ADJUST value, even with the power off.

100.0%
20.00 mA



4.00 mA
0.0%

Note: The same ADJUST value is stored for both mA and %. The recalled value will be displayed in the units you have selected.

OPEN LOOPS



The display will indicate 0.00 mA or -25.0% if there is an open loop or if the polarity is reversed. Check all the connections in the loop or try reversing the leads.

POWER TRANSMITTER

Adjusting the SOURCE output to full scale supplies a nominal 24V DC to power a two wire transmitter while simultaneously displaying the 4 to 20 mA output of the transmitter.

READ MILLIAMPS

Select read milliamps by moving the slide switch to mA or % 4 to 20 mA and moving the left hand toggle switch to READ. Place the Model 334A in the loop in series with the current to be measured.

READ DC VOLTS

Select read DC Volts by moving the slide switch to READ VDC and moving the left hand toggle switch to READ. Clip the leads across the voltage to be measured.

SETTING UP VALVES

When setting up a valve it is important to correctly set the end stops. Use the 334A to supply the 4 to 20 mA control signal to stroke the valve. Select SOURCE to output using the internal batteries as the power source or 2-WIRE SIMULATOR to stroke the valve using an external power supply.

- 1) Disconnect the 4-20 mA control wires from the Current-to-Pressure (I/P) converter or the actuator.
- 2) Connect the 334A following the connection diagrams on the next page for SOURCE or SIMULATE 2-WIRE TRANSMITTERS.
- 3) Move the Quik-Chek switch to 4.00mA/0.0% and adjust the fully closed stop on the actuator.
- 4) Turn the 334A's knob slowly counterclockwise and verify that the actuator and valve don't move. Repeat steps 3 & 4 until no movement is detected.
- 5) Move the Quik-Chek switch to ADJUST and quickly back to 4.00mA/0.0% then turn the 334A's knob clockwise. The actuator and valve should begin to move.
- 6) Move the Quik-Chek switch to 20.00mA/100.0% and adjust the fully open stop on the actuator.
- 7) Turn the 334A's knob slowly clockwise and verify that the actuator and valve don't move. Repeat steps 6 & 7 until no movement is detected.
- 8) Move the Quik-Chek switch to ADJUST and quickly back to 20.00mA/100.0% then turn the 334A's knob counterclockwise. The actuator and valve should begin to move.

OPERATING INSTRUCTIONS

SOURCE MILLIAMPS

mA OUT, % OUT (Percent of 4 to 20 mA)

Choose this function to provide an output from 0.00 to 24.00 milliamps. The compliance voltage is a nominal 24 VDC to provide the driving power to your milliamp receivers.

- 1) Disconnect one or both input wires from the device to be calibrated.
- 2) Move the slide switch to mA or % 4 to 20 mA and move the left hand toggle switch to SOURCE.
- 3) Connect the red SOURCE lead of the calibrator to the plus (+) input of the device and the black SOURCE lead to the minus (-).

Output current is adjusted by turning the knob. Span and Zero outputs are available by moving the QUIK-CHEK switch to recall 20.00 & 4.00 mA.

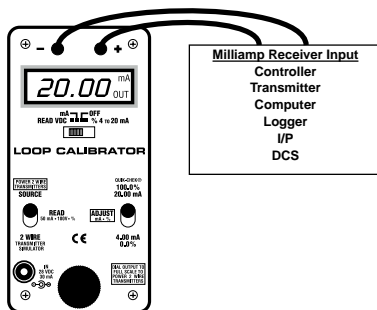

READ MILLIAMP OUTPUTS

READ mA, READ % (Percent of 4 to 20 mA)

Choose this function to measure from 0.00 to +52.00 milliamps or -25.0 to 300.0%.

- 1) Open the current loop at any convenient point along the signal path
- 2) Move the slide switch to mA or % 4 to 20 mA and move the left hand toggle switch to READ.
- 3) Connect the red READ (+) lead of the calibrator to the more positive point of the break and the black READ (-) lead to the more negative

Signals below 0 mA or open circuits are indicated by 0.00 mA (-25.0%) on the display. Signals above 52 mA are current limited by protection circuitry to approximately 55.00 mA.

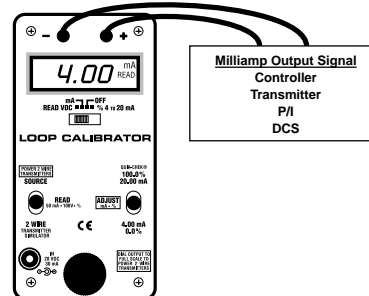

SIMULATE 2-WIRE TRANSMITTERS

2-WR mA, 2-WR % (Percent of 4 to 20 mA)

Choose this function to simulate a 2-Wire Transmitter output from 0.00 to 24.00 milliamps. Operates in loops with power supply voltages from 3 to 100 VDC.

- 1) Disconnect one or both input wires from the device to be calibrated.
- 2) Move the slide switch to mA or % 4 to 20 mA and move the left hand toggle switch to 2 WIRE TRANSMITTER SIMULATOR.
- 3) Connect the red lead of the calibrator to the plus (+) input of the field connections and the black lead to the minus (-)

Loop current is adjusted by turning the knob. Span and Zero outputs are available by moving the QUIK-CHEK switch to recall 20.00 & 4.00 mA.

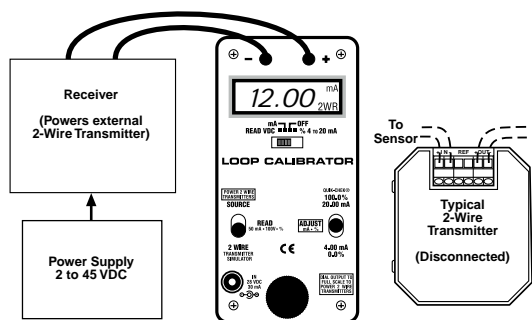

POWER & MEASURE 2-WIRE TRANSMITTERS

mA OUT, % OUT (Percent of 4 to 20 mA)

Choose this function to simultaneously supply power to a 2-Wire transmitter while displaying the 4-20 mA output of the transmitter.

- 1) Disconnect one or both input wires from the 2-Wire Transmitter to be calibrated
- 2) Move the slide switch to mA or % 4 to 20 mA and move the left hand toggle switch to SOURCE.
- 3) Turn the knob clockwise several times until full scale output (24.00 mA/125.0%) is obtained (this can be verified by clipping the outputs leads together and checking that the display indicates 24.00 mA/125.0%).
- 4) Connect the red SOURCE lead of the calibrator to the plus (+) input of the device and the black SOURCE lead to the minus (-)
- 5) Connect a sensor or calibrator to the input of the 2-Wire Transmitter

Model 334A supplies a nominal 24 Volts DC at 24 mA to the 2-Wire transmitter. The current passed by the transmitter will be accurately displayed by the 334A. Calibrate the Transmitter in the usual manner and disconnect the 334A.

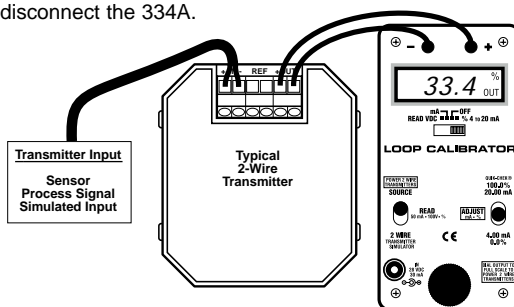

READ DC VOLTS

READ V

Choose this function to measure from -99.99 to +99.99V DC.

- 1) Move the slide switch to READ VDC and move the left hand toggle switch to READ.
- 2) Connect the red (+) and black (-) lead leads across the voltage to be measured

Any DC Voltage from -99.99 to +99.99 Volts may be measured. Loop power supplies, signal voltages at receivers, batteries and transmitter voltage drops may be measured. Signals exceeding ± 100 VDC will be indicated by OVRLD on the LCD.

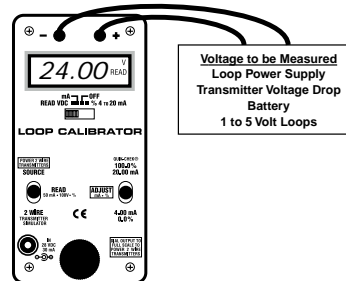

SPECIFICATIONS

(Unless otherwise indicated, specifications are for 1 year in \pm % of Reading @ 23°C)

GENERAL

ACCURACY:

Quik-Chek 4 & 20 mA \pm (0.03% of Setting + 1 LSD)
Milliamp & % Ranges \pm (0.05% of Reading + 1 LSD)
Read DC Volts \pm (0.05% of Span + 1 LSD)

WARM UP TIME: 10 seconds to specified accuracy, 2 minutes to maximum accuracy

TEMPERATURE EFFECT:

Milliamp Ranges: \pm 0.008% of Reading/°C
Read DC Volts: \pm 0.012% of Span/°C

BATTERIES: Three "9V", (1604) batteries (Alkaline supplied and recommended)

BATTERY LIFE:

SOURCE & POWER TRANSMITTER: Nominal
33 hours at 12 mA, 20 hours at 20 mA with 250 Ohm load
READ mA, DC V & 2-WIRE SIMULATE: Nominal 100 hours

LOW BATTERY INDICATION: "BAT" indication will first appear on the display when approximately 4 hours remain to source 12 mA into 250 Ohms. This is typical use for a full shift.

OVERVOLTAGE PROTECTION: Protected to 135V AC/DC for 30 seconds without fuses

OPERATING TEMPERATURE RANGE: -5 to +140 °F (-20 to +60°C)

STORAGE TEMPERATURE RANGE: -22 to +160°F (-30 to +70°C)

RELATIVE HUMIDITY: 10 to 90%, non-condensing for 24 hours from 0 to 35°C

OVERALL SIZE: 121.9 x 66.0 x 35.8 mm (4.8 x 2.6 x 1.41 inches)

WEIGHT: 0.22 kg (7.8 oz)

Specifications subject to change without notice

MILLIAMP SOURCE

RANGES:

0.00 to 24.00 mA; -25.0 to 125.0 % of 4 to 20 mA

ACCURACY:

Quik-Chek 4mA \pm (0.03% of 4mA + 0.01 mA) = 0.011mA
Quik-Chek 20mA \pm (0.03% of 20mA + 0.01 mA) = 0.016mA
0 to 24mA \pm (0.05% of Reading + 1 LSD)

TYPICAL DRIVE CAPABILITY: 1200 Ohms @ 20.00 mA with fresh batteries, 800 Ohms @ 20.00 mA with low batteries

COMPLIANCE: nominal 27VDC @ 20 mA with fresh batteries

POWER & MEASURE 2-WIRE TRANSMITTERS

RANGES & ACCURACY: Same as for MILLIAMP SOURCE

OUTPUT CURRENT: up to 24.00 mA

TYPICAL DRIVE CAPABILITY: 1200 Ohms @ 20.00 mA with fresh batteries, 800 Ohms @ 20.00 mA with low batteries

COMPLIANCE: nominal 27VDC @ 20 mA with fresh batteries

2-WIRE TRANSMITTER SIMULATOR

RANGES & ACCURACY: Same as for MILLIAMP SOURCE

LOOP VOLTAGE LIMITS: Minimum, 2 VDC; Maximum 100 VDC

OVERLOAD PROTECTION: Current limited to 25 mA nominal

MILLIAMP READ

RANGES:

0.00 to 52.00 mA; -25.0 to 300.0 % of 4 to 20 mA

ACCURACY: Same as for MILLIAMP SOURCE

VOLTAGE BURDEN: 0.9V at 4 mA, 1.2V at 20 mA, 1.9V at 50 mA excitation current

READ DC VOLTS

RANGE: -99.99 to +99.99V DC

INPUT IMPEDANCE: >2 Meg Ohms

ADDITIONAL INFORMATION

OTHER PRODUCTS

Altek designs and manufactures fast, accurate instruments for measurement, generation and simulation of virtually every process control signal. Consult our factory directly or contact your local stocking representative to order precise, low cost Milliamp Calibrators, Voltage Sources, Thermocouple Sources, RTD Simulators, Frequency Calibrators and Pressure Pumps, Indicators & Calibrators. Altek also produces calibrators for custom ranges and unique applications. New models are frequently added to the Altek family to meet all of your critical calibration requirements. Altek products are made in the USA.

THREE YEAR WARRANTY

Our equipment is guaranteed against defective material and workmanship (excluding batteries and leads) for a period of three years from date of shipment. Claims under guarantee can be made by returning the equipment prepaid to our factory. The equipment will be replaced, repaired or adjusted at our option. The liability of Altek is restricted to that given under our guarantee. No responsibility is accepted for damage, loss or other expense incurred through sale or use of our equipment. Under no condition shall Altek be held liable for any special, incidental or consequential damage.

ORDERING INFORMATION

Loop Calibrator

Part No.

334A

Included with each Model 334A are:

Attached test leads with alligator clips

Data Sheet 334A

NIST Traceable Certificate and Three Year Warranty

Padded Carrying Case with Shoulder Strap & Belt Loop (09-3782)

OPTIONAL ACCESSORIES

AC ADAPTOR (100 TO 120 VAC)

Part No.

28-1020

AC ADAPTOR (200 TO 240 VAC)

28-0240

AVAILABLE FROM